

RUSSIAN ACADEMY OF SCIENCES
BUDKER INSTITUTE OF NUCLEAR PHYSICS
SIBERIAN BRANCH

D.S. Gurov, P.V. Martyshkin, M. Masuzawa,
V.V. Petrov, V.V. Zuev

STEERING MAGNETS FOR THE UPGRADE
OF KEK B-FACTORY

Budker INP 2013-31

NOVOSIBIRSK
2013

**Steering magnets for the upgrade
of KEK B-factory**

D.S. Gurov, P.V. Martyshkin, V.V. Petrov, V.V. Zuev

Budker Institute of Nuclear Physics
630090, Novosibirsk, Russia

M. Masuzawa

High Energy Accelerator Research Organization, Tsukuba, Japan

Abstract

Two types of vertical dipole correctors for the main ring of Super KEK B-factory have been manufactured. Design of correctors and process of magnetic field measurements are described. Basic results of magnetic field measurement are included.

@ Budker Institute of Nuclear Physics SB RAS

Introduction

The design and manufacturing of the set of vertical dipole correctors together with supports for the Super KEK B-factory were performed in 2011-2012 in the frame of the contract No.BSU 0037 between Budker Institute of Nuclear Physics (Russia) and Toyota Tsusho (Japan)

1. Parameters of correctors

The main parameters of correctors which were assumed as a basis for the design are presented in Table 1. These parameters were proposed by representatives from KEK as a preliminary specification for further justification within the contract. The overall length of the magnet together with the coils should be not more than 320 mm.

Table 1

	Units	Arc V-Corrector	Straight V-Corrector
Number of correctors		190	30
Type of core		C-shape, laminated	
Material of core		Steel M940-50A ThyssenKrupp Stahl	
Thickness of lamination	mm	0.5	
Length of yoke	mm	200	
Overall length of corrector along the beam axis	mm	≤ 320	
Transversal size of magnet	mm×mm	400 × 440	410 × 440
Gap size	mm	280	290
Magnetic field in the center of magnet	mT	34	37
Integral of magnetic field	mT·m	15	16
Good field region	mm	± 20	
Homogeneity in the good field region		10^{-2}	
Number of coils		2	
Type of conductor	round	$\varnothing 2$ mm	
Number of turns in a coil		896	1024
Current	A	≤ 5	

It is seen from the Table 1 that both types of correctors have a wide gap size of 280 and 290 mm, approximately 1.5 times larger than the length of the core (200 mm). Thus, the magnetic system is almost open. In this case the influence of stray field on the geometry of magnetic field in the operating area of the corrector becomes very important. This effect has to be taken into account during numerical simulation of the magnetic field topology.

Computation of geometrical parameters of the cores and coils was initially performed by using a 2D-version of MERMAID code which was developed in BINP. Then these parameters were justified by using a 3D-version of MERMAID.

Simulation showed that usage of shims for the core just slightly improves the homogeneity of magnetic field in operation area of the corrector. In particular, a 5 mm high shim for Arc V-corrector type (280 mm aperture) improves the homogeneity in median plane $Y = 0$ only by $\sim 2 \cdot 10^{-3}$ inside ± 4 cm in X direction. From another hand the amplitude of magnetic field in the gap decreases by 2.8%. Taking into account these reasons it was decided to reject shimming of the yoke and, consequently, to simplify the design of the die and to increase its reliability.

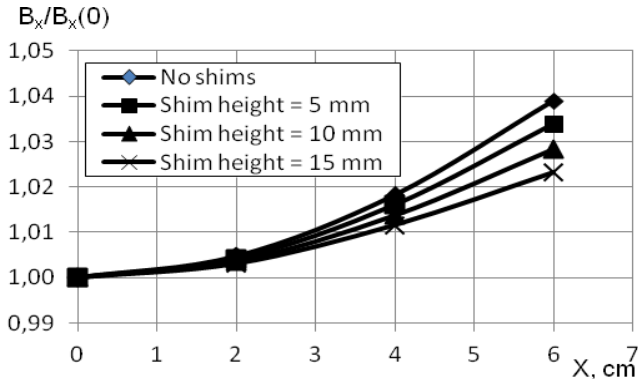

Fig. 1. Effect of shimming of poles on homogeneity of magnetic field in the gap (2D calculation).

2. Design of correctors

Both types of the correctors are almost similar in design, the technology of their manufacturing is practically the same. The corrector consists of a dipole magnet and an adjustable support (Fig. 2). Both types of the magnets consist of a laminated C-shape yoke (2) and two coils of excitation (1). The difference between the types is only in the inter-pole distances (280 mm for Arc V-corrector and 290 mm for Straight V-corrector). Correspondingly, the width of the yoke will differ by 10 mm while the width of laminations is the same.

The adjustable support (3) consists of a cylindrical steel tube accompanied by upper and lower steel plates. The corrector stands on the plate-support (6) on four

stainless steel posts (7) of a 16 mm diameter. In such a way an interruption of magnetic flow between the yoke and the steel support is guaranteed. The adjusting mechanism consists of the bolts (5), the posts (7) and the fixing studs (4) and permits to execute alignment of the corrector within ± 20 mm in vertical plane and ± 10 mm in horizontal one.

The corrector operates within low magnetic fields, about 500 Gauss, that is why the thickness of the yoke is comparatively thin, 60 mm, and the material of the yoke operates within the area which is far from saturation. The main problem of manufacturing the die for a C-shape yoke with typical cross dimensions of 410×440 mm and lamination width of 60 mm lies in an unpredictable tapering of the punched lamination because of the internal stress of material of a billet. Extent of this tapering can be different for different lots of the supplied steel. Thus, the magnetic gap can be very different in a vertical direction.

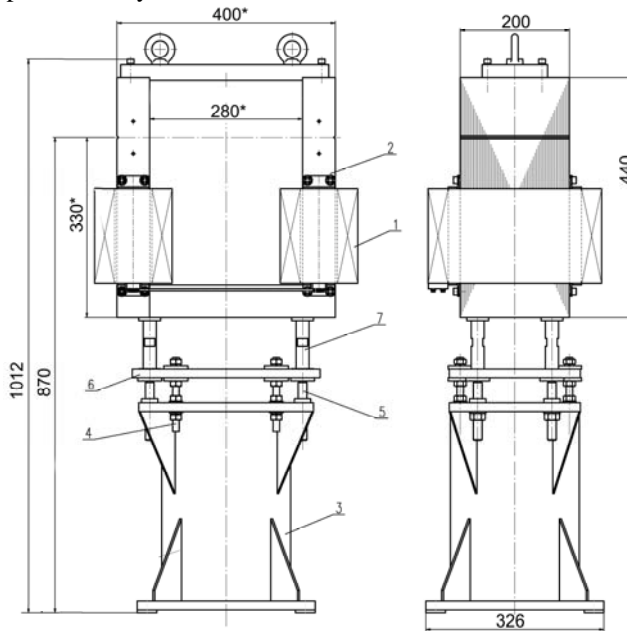

Fig. 2. General view of Arc V-corrector together with support.

To avoid this effect it is necessary to make two dies – rough and finishing – for each type of the magnet size; or to provide a special compensation in the design of the magnet. Strictly speaking, this requirement is not so reasonable as the operating area for beam is essentially lower than the gap size (the greater part of the vacuum chamber is used for the radiation receivers). The numerical simulation shows that tapering of the poles even by 5 mm does not influence X- and Y-homogeneity of the magnetic field, although the absolute amplitude of the magnetic field in the center of the magnet decreases by $\sim 1.5\%$ (Fig. 3).

To avoid effect of uncontrollable tapering of the poles during punching and to minimize expenses, the decision to assemble the magnetic yoke using three separate laminations was taken. The vertical plates have width of 60 mm and length of 440 or 380 mm. The horizontal plates have width of 60 mm and length of 340 or 350 mm. The laminations are stacked by alternating the sequence of even-odd layers to provide a reliable gluing of a block.

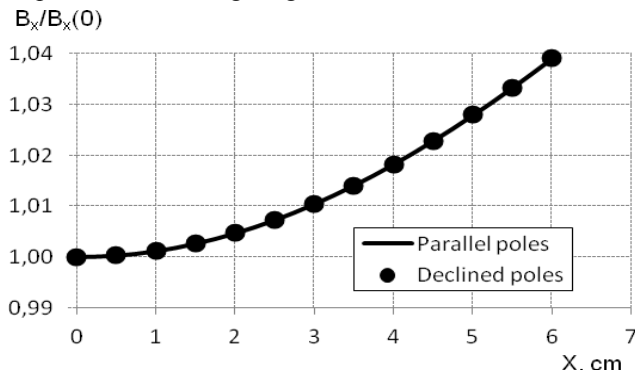

Fig. 3. Homogeneity of magnetic field with parallel and tapered poles (2D-simulation)

The yokes were assembled on special stacking tooling using punched laminations of electro-technical steel M940-50A (ThyssenKrupp AG Company) with thickness of 0.5 mm and Stabolit 70 coating on both sides.

The yokes of the magnets were clamped together on the top with a special nonmagnetic plate to prevent deformation of the magnetic gap during work and to provide lifting of the magnet during transportation and mounting. Materials of the plate are: stainless steel for Arc V-correctors and duralumin D16T for Straight V-correctors.

Coils have been designed basing on the main parameters of correctors which were specified in the Contract Specifications. However, using of round conductor is not a very convenient and technological decision because of the necessity to use an inter-layer insulation during winding. Therefore, it was decided to use rectangular copper conductor with a $1 \times 4 \text{ mm}^2$ cross-section, type PSDKT with glass fiber insulation which is impregnated with glyptal lacquer (Russian Standard GOST7019-80). Thermal resistance class of this conductor is F (155°C). It is not necessary to use additional inter-layer insulation for this type of conductor: turns lie very smoothly and tightly. Cross-section of the copper conductor is increased by $4/\pi$ and energy-release in coils is correspondingly less. The number of turns in coils was changed as compared with the basic Specifications (Table 1) to guarantee the required number of Amper-turns and an even number of layers in the coils. So, the number of turns in the coil is 902 for Arc V-corrector and 1034 for Straight V-corrector.

Coils are wound with entire conductor, without intermediate soldering using a special winding device (Fig. 4). The device has the system of calibrated tension of conductor.



Fig. 4. Winding device and manufactured coils.

Impregnation is carried out with epoxy compound in vacuum vessel followed by baking in specially manufactured mould. After cooling the surfaces of the coils are conditioned and covered with epoxy lacquer. Then geometrical, mechanical and electrical parameters of coils are checked by the testing and quality control laboratory. Simultaneously, checking of absence of short-circuited turns is performed.

Special electrical terminal for connection of the coil with a power supply is also impregnated in epoxy compound (Fig. 5). It guarantees reliability of electrical connection and protect a coil wire from breaking.

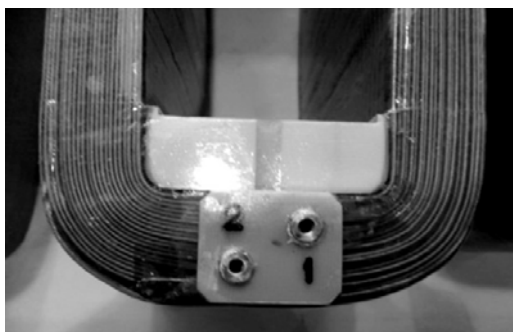

Fig. 5. Fixation of the outlets of coils.

Special insertions made of fiber-glass plastic guarantee accurate fixation of the coils on the yoke.

3. Manufacturing of yokes and coils

Assembling of yoke is executed in staking tooling to ensure the required tolerance ± 0.2 mm for inter-pole gap. Number of layers of interleaving, flatness of surfaces, overall weight of laminations has been checked during assembling of the yoke. Moreover, it was necessary to guarantee deflection from nominal length of the magnet of no more than ± 0.2 mm and stacking factor of 98%. Special Belleville washers were used for uniform compression of the stacked block. Compressive force of 15 kg/cm^2 was controlled by torque wrench.

After baking of the yoke regular measurements of its main geometrical dimensions were carried out: inter-pole distance was measured at three points, at front plane, in the center and at back plane at central area of poles, length of the magnet was also measured at three points. Deviation of the length of a 200 mm yoke has to be no more than ± 0.2 mm.

Electrical measurements and tests were carried out after manufacturing of the coils. Electrical resistance was normalized to 20°C . Absence of short-circuited turns was checked. Test of inter-turn insulation was checked.

Test of outer electrical insulation between the yoke and the coils was carried out after final assembling of the corrector (had to be more than 50 M Ω). Measurement of inductance of the whole corrector was also carried out. Insulation test included application of 500 V DC voltage for one minute between both coils and the yoke. Each manufactured corrector was accompanied by Technical Passport where all results of measuring the parameters of the yoke and the coils and the results of electrical tests were indicated.

4. Magnetic measurements

The procedure of standard magnetic measurements consisted of measurement of excitation curve depending on current change from 0 to 5 A and back to 0 A in the central point of corrector. Step of current was 0.5 A. The measurement was carried out for each corrector. Moreover for five occasionally chosen correctors of each type measurement of field map in a vertical plane was carried out. Step of these measurements in a vertical plane is 5 mm, total vertical area of field mapping is ± 50 mm.

The measurements were carried out with two sets of Hall probes combined correspondingly in two space matrixes. The first one, so-called “wide-size” matrix, consisted of 19 Hall probes which were placed across the beam axis with a 5-mm inter-probe distance. The Hall probes are glued to the surface of the copper carriage made with high mechanical accuracy. During the measurement, the matrix carriage is moved along the beam axis inside of a special guide. Mechanical accuracy of manufacturing of the guide together with the accuracy of knowledge of coordinates of the probes within the matrix carriage guarantees referencing of the probes to the base planes of the elements with the accuracy no worse than

300 micrometers. This matrix provided the field mapping by one pass along the longitudinal corrector axis within 100-mm range in a vertical direction.

The second one, “narrow-size” matrix consisted of 5 Hall probes and was used for measurement of excitation curve. The matrix carriage has a thermostabilization system – this allows avoiding regular calibration of Hall probes.

The length of the correctors of both types is shorter than the inter-gap distance, thus, the stray-fields have an important impact upon the amplitude and integral of magnetic field. It was necessary to guarantee a relative accuracy of magnetic field measurement of about 10^{-3} that corresponds to about 0.35 Gs (0.035 mT) in correctors at working point. At the same time the absolute limit of accuracy for Hall probes is also ~ 0.35 Gs. Before starting the measurements, it was necessary to perform an every-day standard heating of Hall probes for 1 – 1.5 hours to guarantee the required accuracy.

A special mandrel was produced to measure the field in the center of the magnet. The device allowed positioning of the Hall probes always in the same location. This provided fine precision of the measurement.

Each measurement of the correctors was preceded by a standard cycle of normalization consisting of a four-time slow increase of excitation current from 0 A up to 6 A at speed of 0.2 A/sec, holding the maximal current for 25 seconds and slow decrease down to 0 A. Measurement of excitation curve was carried out in the range from 0 A to 5 A with a 0.5 A step. After normalization cycle, the excitation current was slowly increased up to the required level. This value was held for 35 seconds while measurement of the magnetic field was carried out. Then the excitation current was increased automatically to the next level and the whole cycle of measurements was repeated. After measuring the magnetic field at 5 A, the measurement cycle was repeated automatically in the reverse order down to 0 A.

Excitation current amplitude was measured synchronously with the magnetic field value. Co-measurement of the both values allows avoiding the errors caused by instability of the power supply. In this case it is possible to perform recalculation of the magnetic field values for the predetermined value of excitation current.

Another possible reason of the errors in measurements is the necessity to perform the magnetic field measurements with the absolute accuracy which is almost equal to the resolution of the Hall probes. To exclude the effect of fluctuation of Hall probe, the measurements were carried out during 35 seconds for each value of the excitation current. Then the procedure of recalculation of the measured field values to some fixed excitation current value was carried out. The next step was calculation of the magnetic field average value at each fixed value of excitation current. Averaging was carried out approximately for 40 measured points, the first 7 counts were rejected.

Figure 6 represents the final excitation curves of Arc V-Correctors and Straight V-Correctors.

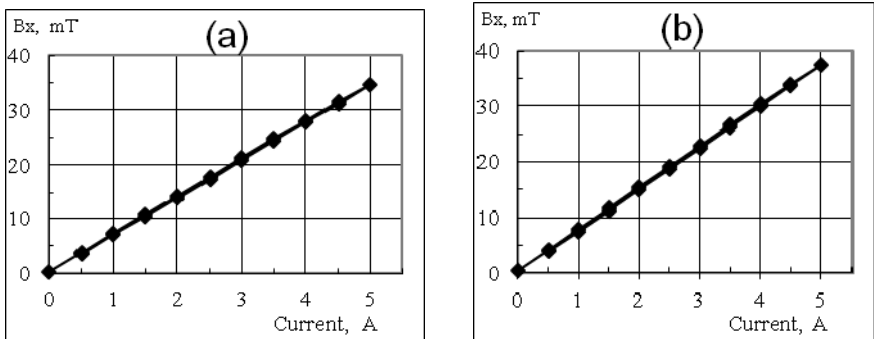

Fig. 6. Excitation curves of Arc V-Corrector (a) and Straight V-Corrector (b).

Difference of induction in the center of the magnet at current ~ 2.5 A during forward and return run of the excitation loop (see Fig. 7) is ~ 0.5 mT or $\sim 1.5\%$ of B_{max} , this corresponds to ambiguity in the deflection angle $< 10^{-2}$ mrad at 8 GeV.

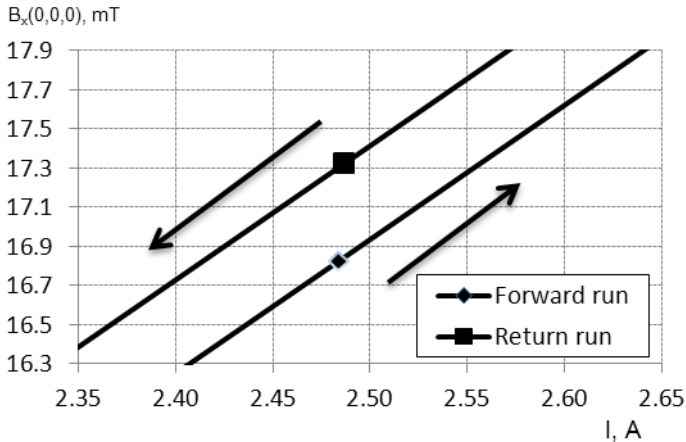

Fig. 7. Width of the hysteresis loop of Arc V-Corrector type.

When measuring the map of magnetic fields the matrix carriage is moved along the longitudinal axis of the corrector with a 10 mm step within ± 800 mm from the center of the magnet on a special guide. The measurements of the field map were carried out at 5 A excitation current. The guide was preliminary centered relative to the magnet, correctness of joint horizontality of alignment of the corrector and the guide was carefully checked with a level.

Figure 8 shows the results of measuring of the magnetic field of Arc V-Corrector type along the beam axis. Figure 9 shows the homogeneity of the magnetic field in a vertical plane in the middle of the magnet. It can be seen that homogeneity of field region is not less than 1% within ± 25 mm in a vertical direction.

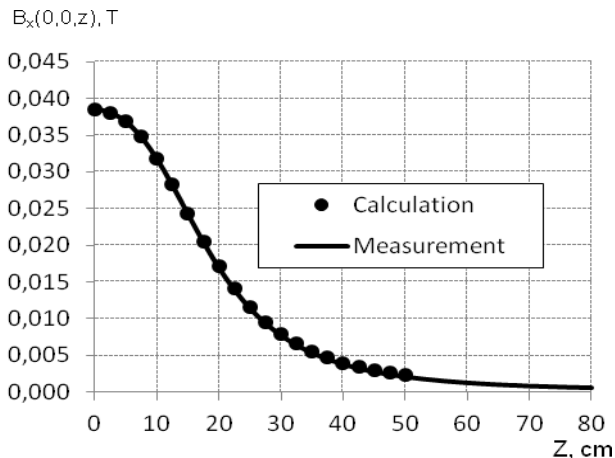

Fig. 8. Horizontal field B_x along the beam axis

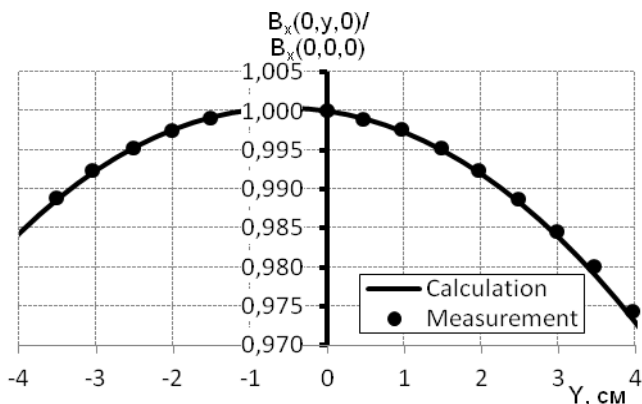

Fig. 9. Homogeneity of horizontal magnetic field in the middle of the magnet in a vertical direction.

The homogeneity of the integral field of the corrector is shown in Fig. 10. These values are obtained from the weighted average value of the magnetic field and the integral.

Diagrams for the homogeneity of the field for Straight V-corrector are similar.

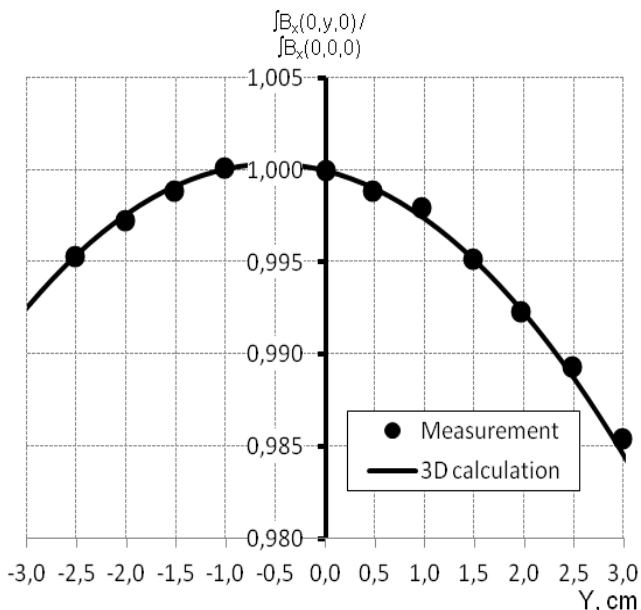

Fig. 10. Arc V-corrector type. Homogeneity of the integral of horizontal field in a vertical direction.

Repeatability of the parameters of the corrector, i.e. the mean value and rms scattering, is very important in manufacture of a large batch of correctors. Longitudinal integral of magnetic field is, of course, a cardinal parameter of the corrector. Knowledge of the average value of the field integral and its dispersion would be very important. However, the field map was measured only for 5 correctors of each type in accordance with the requirements of the Specification. Therefore, calculation of the average value and dispersion for such a small amount of data is almost meaningless.

At the same time the maximum value of the corrector field in the center was measured for both types of the magnets. Thus, the value of the magnetic field in the center of the magnet at 5 A excitation current can be taken for calculation of statistical parameters.

Figure 11 shows statistical distribution of Arc V-Corrector over the maximum field in the center of the magnet. The mean value of the field is 34.71 mT with a relative standard deviation of $7.6 \cdot 10^{-4}$. The right side asymmetry of the distribution in the histogram is explained by the fact that the first 8 correctors of this series were measured with a wide-aperture carriage with 19 Hall probes, and the other correctors were measured with a carriage with 5 Hall probes. Neglecting the non-symmetrical measurements on the right side of the histogram, one can see that the maximal difference from the mean value is approximately ~ 0.05 mT (0.15 %).

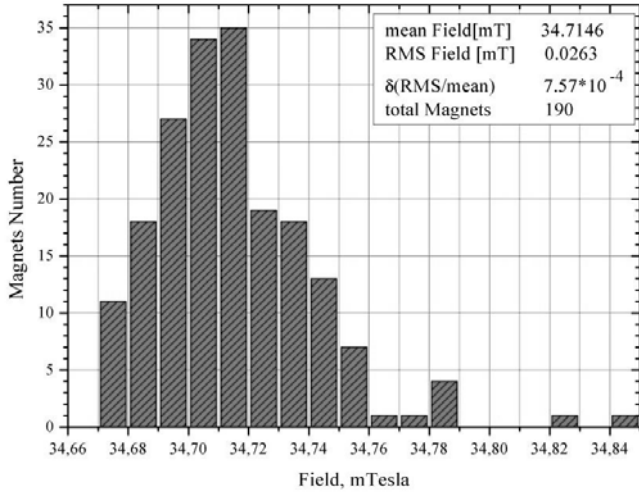

Fig. 11. Histogram of magnetic field distribution of Arc V-Corrector type.

Statistical distribution of magnetic fields for Straight V-Corrector type is shown in Fig. 12. The mean value of the field is 37.44 mT with a relative standard deviation $4 \cdot 10^{-4}$. Maximal deviation from the average value is about 0.03 mT (less than 0.1%). Statistical dip nearby the average value of the field is caused by the fact that only 30 correctors of the second type were manufactured. In principle, distribution can differ from a normal distribution for such a small statistical sample.

The values of standard deviations for both types of the correctors show a well repeatability in the manufacture of the magnets.

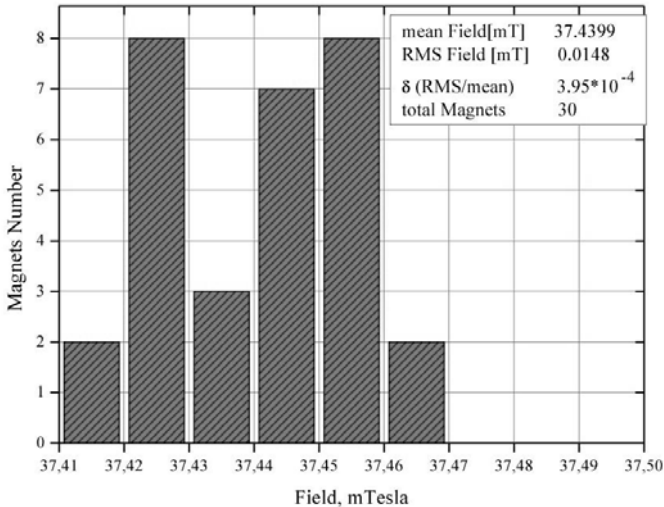

Fig. 12. Histogram of magnetic field distribution of Straight V-Corrector type.

The final parameters of the KEK Correctors are presented in Table 2.

Table 2

Final parameters of KEK correctors

	Units	Arc V-Corrector	Straight V-Corrector
Number of correctors		190	30
Type of core		C-shape, laminated	
Material of core		Steel M940-50A ThyssenKrupp Stahl	
Thickness of lamination	mm	0.5	
Length of yoke	mm	200	
Overall length of corrector along the beam axis	mm	≤ 320	
Transversal size of magnet	mm×mm	400×440	410×440
Gap size	mm	280	290
Magnetic field in the center of magnet	mT	34.71	37.44
Integral of magnetic field	mT·m	15.05	16.41
Good field region	mm	± 25	
Homogeneity in the good field region		10^{-2}	
Number of coils		2	
Type of conductor	Rectangular	PSDKT 1×4 Russian Standard GOST 7019-80	
Number of turns in a coil		902	1034
Current	A	≤ 5	

In June 2012, the last batch of correctors was shipped to KEK (Japan). In the late summer of that year, all correctors were installed in the tunnel of the main ring of the accelerator complex.

Contents

Introduction.....	3
1 Parameters of correctors	3
2 Design of correctors.....	4
3 Manufacturing of yokes and coils.....	8
4. Magnetic measurements	8

*D.S. Gurov, P.V. Martyshkin, M. Masuzawa,
V.V. Petrov, V.V. Zuev*

**Steering magnets for the upgrade
of KEK B-factory**

Budker INP 2013-31

Ответственный за выпуск А.В. Васильев
Работа поступила 2.12. 2013 г.

Подписано в печать 2.12. 2013 г.

Сдано в набор 3.12. 2013 г.

Формат 60x90 1/16 Объем 1,0 печ.л., 0,8 уч.-изд.л.

Тираж 100 экз. Бесплатно. Заказ № 31

Обработано на РС и отпечатано
на ротапринтере «ИЯФ им. Г.И. Будкера» СО РАН,
Новосибирск, 630090, пр. Академика Лаврентьева, 11